

Hysteresis Clutch, Brake

MODEL

ZHA Hysteresis Clutch

ZHY Hysteresis Brake

Instruction Manual

Table of Contents

Cautions on Safety - - - - -	1
1. Cautions before use - - - - -	2
2. Structure and principle of operation - - - - -	2
3. Assembling of clutch, brake - - - - -	5
4. Operation- - - - -	6
5. Torque adjustment - - - - -	7
6. Maintenance - - - - -	8
7. Troubleshooting - - - - -	9
8. Specification- - - - -	10
9.Others - - - - -	11



- Read through this manual, and use the unit correctly.
Make sure to understand “Cautions on safety” completely.
- Store this manual carefully, and make sure to send it to the end user.

Cautions on Safety

(Make sure to read this page before using the unit.)





Please read through this instruction manual and other technical data, and handle the unit correctly while paying rigid attention to safety.

In this manual, the level of safety precautions are classified into “**DANGER**” and “**CAUTION**”.

 DANGER	: Erroneous handling may cause a dangerous situation in which the possibility of death or serious injury is expected.
 CAUTION	: Erroneous handling may cause a dangerous situation in which the possibility of not so serious or slight injury is expected or occurrence of material damages exclusively is expected.

In case of trouble, in spite of our best efforts in quality control, it may be assumed to cause continuous running state due to failure of the clutch and the brake, and hence it is advised to pay sufficient consideration to safety measures at the machine side.

Store this manual carefully so that it can be referred to when required, and make sure to send it to the end user.

 DANGER	Use protective cover.
	The rotating elements are exposed outside, and the hand or part of body may be injured if touching the product. Install a protective cover, allowing smooth ventilation, so that part of the body may not be in contact with the machine. It is also recommended to provide with a safety mechanism to stop the rotating elements immediately when the cover is opened.
 DANGER	Never use the unit in an atmosphere in which inflammation or explosion is expected.
	While slipping, a spark may be ignited on the internal working surface. Never use in a flammable or explosive atmosphere with oil or grease. Enclose the main body when using near flammable material such as cotton. When enclosed, however, it must be noted that the allowable heat dissipation is lowered.
 CAUTION	Check the environments.
	Never use in a place exposed to dust, high temperature, dew condensation, or rain and wind. Don't install directly in a place exposed to vibration or impact. Or it may lead to damage or malfunction of the product or deterioration of performance.



CAUTION

- Mitsubishi Electric is not responsible for any damage or trouble caused by repair, disassembly or modification of the product by any third party other than Mitsubishi or specified agent.

For repair or disassembly services, therefore, please call the service network of Mitsubishi.

It must be noted that the specification mentioned in the cautions, instruction manual or technical data is subject to change without notice.

1. Cautions before use

 CAUTION	Never suspend the product by holding the leadwire.
	Or the lead wire may be broken and the product may drop to cause injury. Hold the product itself when attaching or detaching.

Don't pull or tear the lead wire, and handle with care.

2. Structure and principle of operation

- Figures 1 to 4 show typical structures of hysteresis clutch and brake.
- The hysteresis clutch is composed of three parts: stator, first rotor and second rotor.
- The stator has an exciting coil contained inside, and the first rotor comprises inner and outer magnetic poles. Between these magnetic poles, a cupshaped permanent magnet (not magnetized) of the second rotor is interposed.
- Suppose the first rotor is rotated to excite the exciting coil, a rotating magnetic field is generated in a gap formed by the inner and outer magnetic poles of the first rotor, and the permanent magnet of the second rotor placed in the gap is magnetized, but since the permanent magnet has a hysteresis characteristic, the change of polarity of the permanent magnet is later than that of the magnetic poles, thereby coupling the first rotor and second rotor magnetically, so that torque can be transmitted.
- The brake is formed by fixing a stator and a first rotor.

Fig. 1 Structural diagrams of ZHA-5 or less hysteresis clutches
(representative examples)

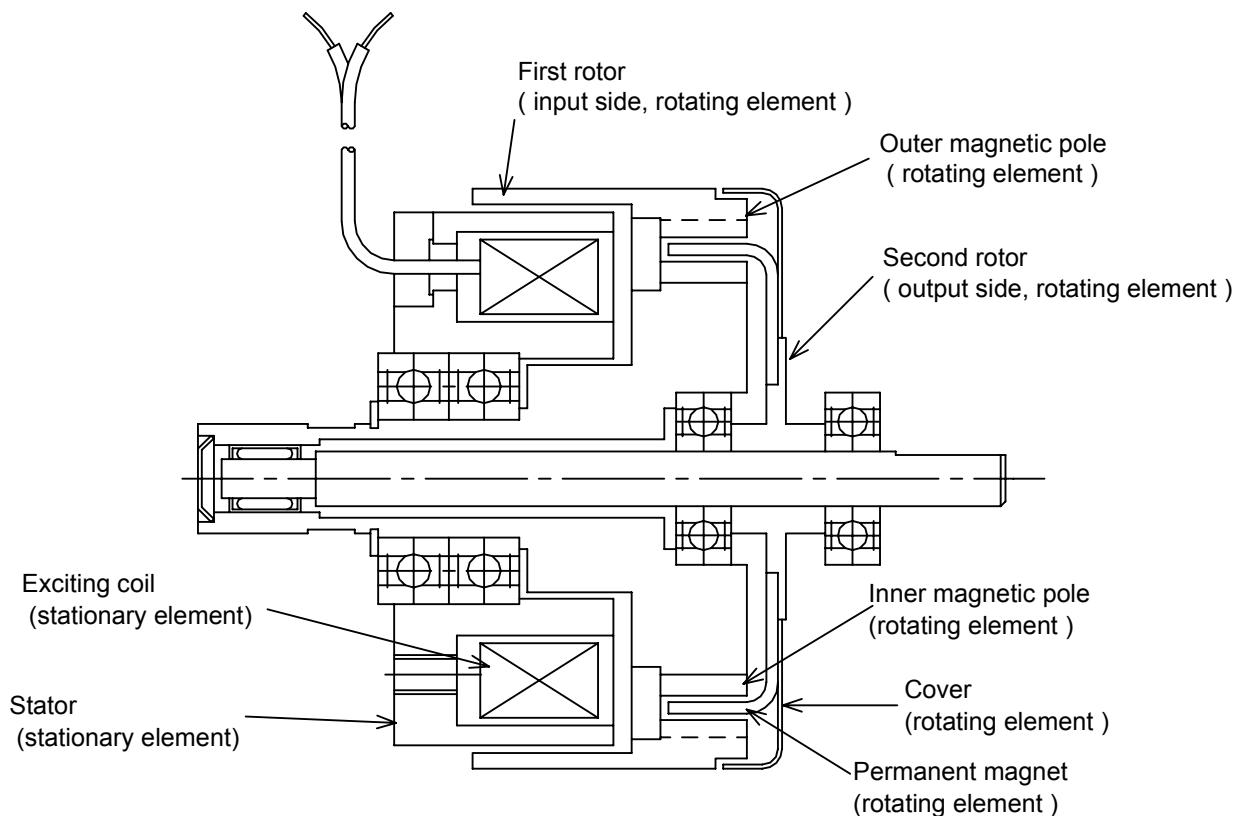

Fig. 2 Structural diagrams of ZHY-5 or less hysteresis brakes
(representative examples)

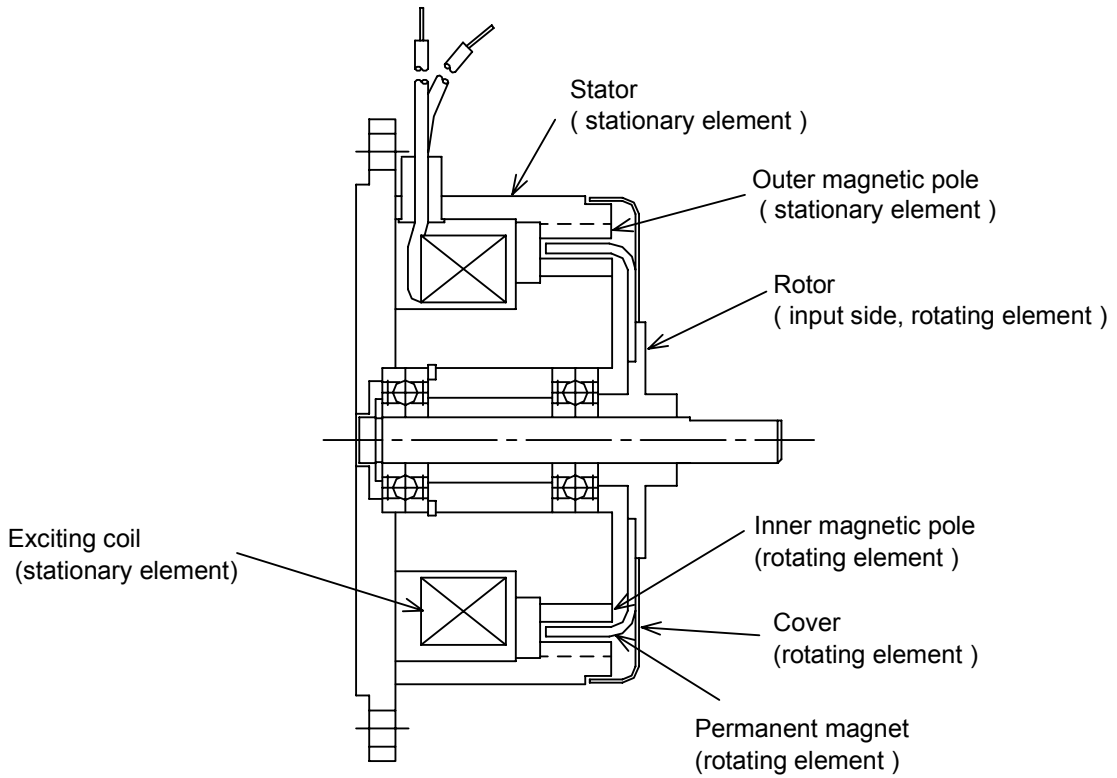

Fig. 3 Structural diagrams of ZHA-10 or more hysteresis clutches
(representative examples)

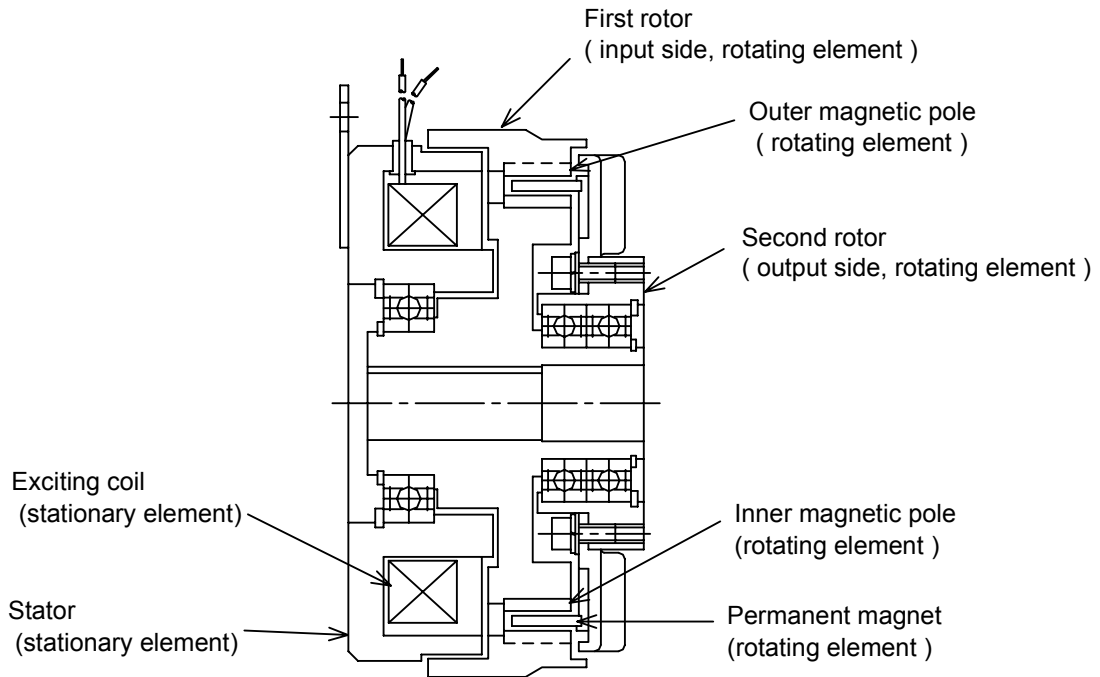
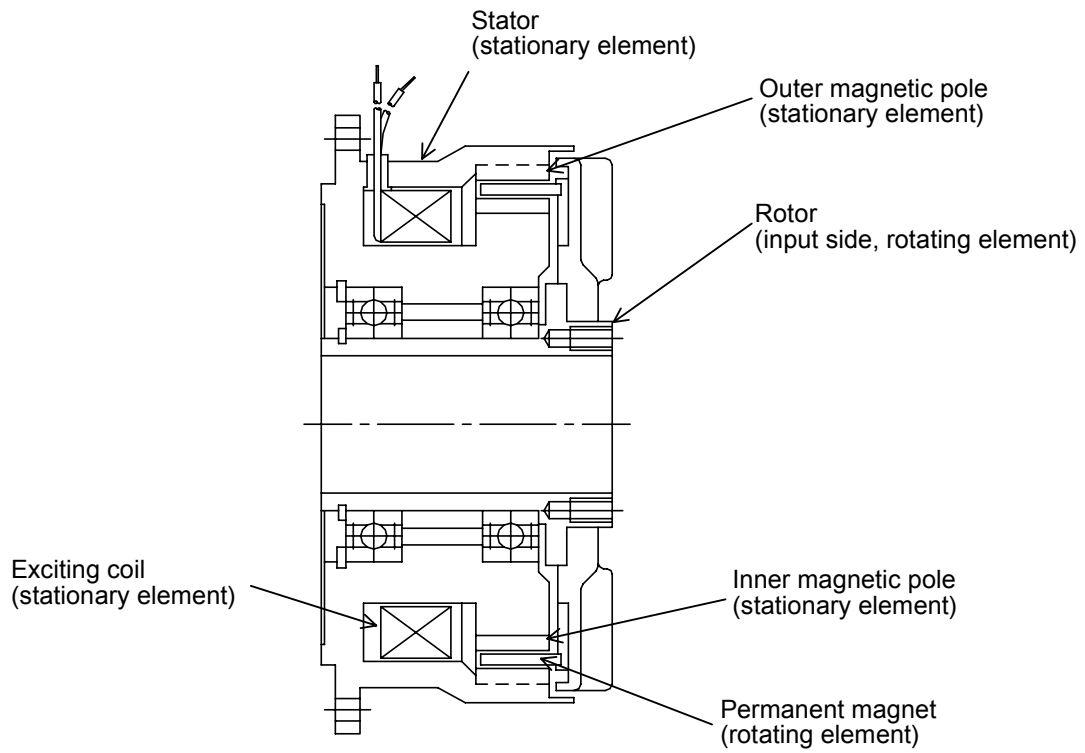











Fig. 4 Structural diagrams of ZHY-10 or more hysteresis brakes
(representative examples)





3. Assembling of clutch, brake

 DANGER	Turn off the power, and make sure rotating elements are stopped.
	Never work while rotating, or it may cause electric shock or injury. When mounting, dismounting, or adjusting, turn off the power source, and make sure the rotating elements are stopped still. At this time, be careful not to have fingers or hand pinched.
 DANGER	Tighten bolts to specified torque, and lock securely.
	Depending on the degree of tightening, the bolts may be broken to cause injury. Using specified bolt material, tighten bolts to specified torque, and lock securely with adhesive, spring washer or the like as specified. Besides, since the parts composing the product rotate relatively to each other, the tightened parts must be fixed securely for the safety of operation. The bolt strength and tightening torque are designated in the specification.
 DANGER	Connect lead wires securely.
	Otherwise it may lead to an electric shock. Connect securely, both electrically and mechanically, and insulate appropriately.
 DANGER	Be sure to connect a surge absorber parallel to the exciting coil to cut off the direct current.
	Cutting off the current may cause a large surge voltage, and the surge voltage may deteriorate the peripheral units. For this reason, be sure to use a surge absorber, such as a diode, varistor, and protective resistor.
 DANGER	Use wire size suited to current capacity.
	If wire of smaller current capacity is used, the insulating coating may melt down to cause insulation failure, possibly leading to electric shock, current leak, or fire. The specified current of the product is designated in the specification.
 CAUTION	Mount, dismount, and transport with greatest care.
	Carrying of a heavy product may cause lumbago or injury by dropping. Be careful sufficiently when mounting, dismounting, or transporting.
 CAUTION	Be careful not to allow the shaft (second rotor) to slip out by mistake.
	In the hysteresis clutch ZHA-5A and under, the shaft (second rotor) is designed to be drawn out. In order to avoid injury due to dropping accident, hold the main body and support the shaft firmly during work, when mounting, dismounting, or carrying.

- (1) In assembling work, don't attempt to put in by force.
- (2) For coupling between the second rotor and the load shaft, use a flexible coupling.
- (3) For pulley coupling, pay attention to the belt tension, and never apply initial tension more than necessary.
- (4) The voltage polarity is not specified.

4. Operation



 DANGER	Never touch the product during operation.
	The rotating elements are exposed outside, and the hand or part of body may be injured if touching the product. Install a protective cover, allowing smooth ventilation, so that the hand or fingers may not be in contact with the machine during operation, and also a safety mechanism to stop the rotating elements immediately when the cover is opened.
 DANGER	Never increase the rotating speed more than allowable.
	If the rotating speed is raised more than allowable, vibration increases to cause breakage and scattering of powder, and it is very dangerous. Rotate within allowable speed, and install protective cover.

(1) Running-in procedure

- Unlike other types of clutch and brake, hysteresis clutch and brake is noncontact type. Therefore running-in is not required.
- Since it has no wearing part, the torque is maintained semipermanently.

(2) Continuous operation

- Depending on the conditions of use, the surface temperature of the hysteresis clutch and brake may rise considerably. Use the product while keeping the surface temperature below 80°C. If the surface temperature exceeds 80°C, relax the operation conditions, and prevent overheat of the product. (Herein, the surface temperature is mentioned on the basis of the ambient temperature of 30°C. The allowable ambient temperature range is 0 to 40°C.)

 CAUTION	Use thermometer when measuring temperature.
	Don't touch directly by hand to avoid burns. Turn off the power source, and make sure the rotating elements are stopped still, and measure with thermometer. Measure promptly.

(3) Residual torque

- When the hysteresis clutch and brake is de-excited while rotating faster than a specific speed (40 to 50 r/min or more), residual torque is not caused, but when de-excited while not rotating, a residual torque (ripple form) of about 5 to 10% of the value before cutting off occurs. To eliminate the residual torque, the following two control methods are known.

- (a) Cut off the current while the relative rotating speed of the first rotor and second rotor (stator in the case of the brake) is more than 40 to 50 r/min, or decrease gradually when the relative rotating speed is low.
- (b) Pass a current of 30 to 50% of the current value before cutting off, in a reverse direction. In this case, if the first rotor and second rotor are mutually free, the pole are deviated and de-exciting effect by reverse exciting is lost, and therefore the both rotors should not be deviated or the input shaft must be fixed.

The residual torque is almost free from effects of uneven torque when used at exciting current of more than 60 to 70% of the current value at the time of cutting off.

5. Torque adjustment

 DANGER	Use within rated torque.
<p>If used over the rated torque, not only the performance deteriorates, but also mechanical breakage or injury may be caused. Hence, use with rated torque. In particular, it must be noted that a torque over the rating may be cause even if used at the rated current, and therefore check the current-torque characteristic, and adjust the exciting current.</p> <p>(In the course of use, the torque gradually declines, and therefore in manufacturing, a proper allowance is considered initially.)</p>	

- The relation of torque and exciting current is almost proportional as shown in Fig. 5, and therefore by adjusting the current, the torque can be easily adjusted.
- Set to a proper value in consideration of the finish of the product or working condition.



 DANGER	Use within the allowable heat dissipation.
	<p>If used over allowable heat dissipation, the clutch may be extremely heated, and the working surface may be extremely hot and red. As a result, a fire may be caused. In addition, the performance may be deteriorated. Be sure to use within the allowable heat dissipation (refer to Fig. 6).</p>

Fig. 5 Exciting current vs. torque characteristics
(representative examples)

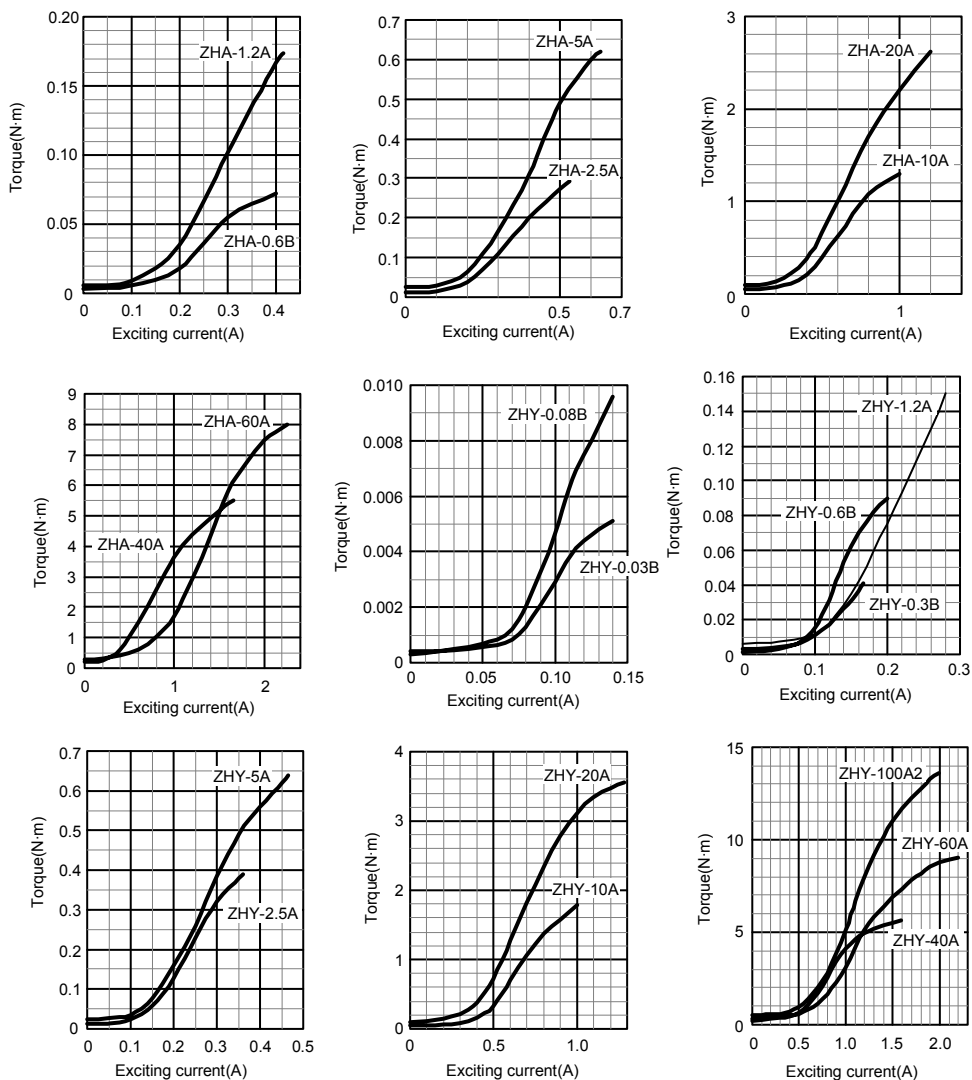
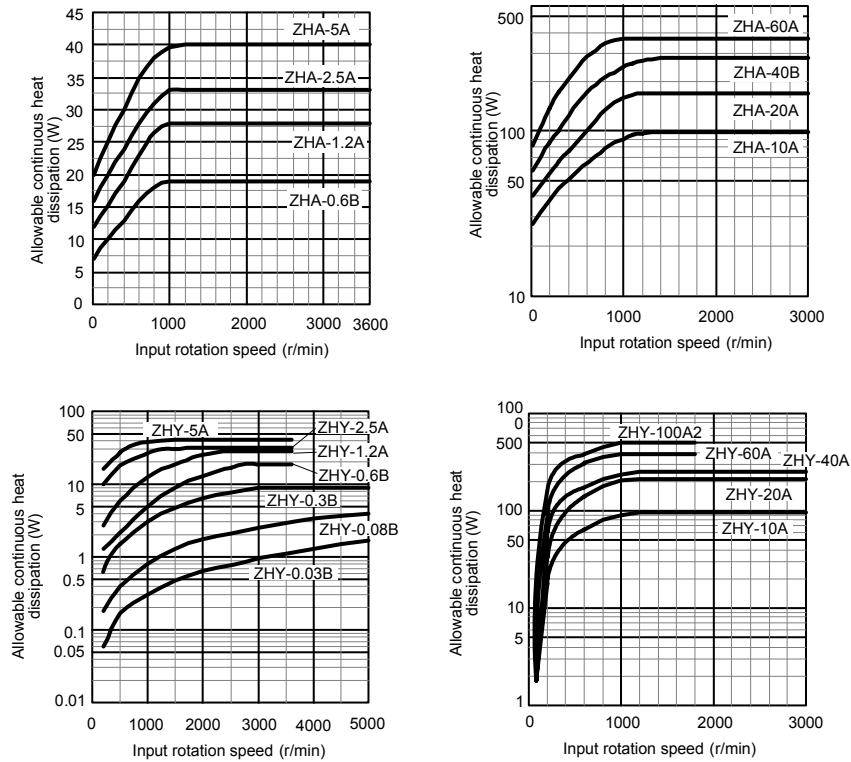



Fig.6 Allowable continuous heat dissipation characteristics



6. Maintenance



Check the following items.

 DANGER	Turn off the power, and make sure rotating elements are stopped.
	Never work while rotating, or it may cause injury. When checking, turn off the power source, and make sure the rotating elements are stopped still. At this time, be careful not to have fingers or hand pinched.

- (1) Unlike the other type of clutch and brake, hysteresis clutch and brake is noncontact type. Therefore it requires no adjustment which is other wise required to compensate time-change. but please avoid to use the unit in the high temperature or high humidity or in the atmosphere full of dust.
- (2) Check the coupling mounting bolts and others for looseness.

7. Troubleshooting

Trouble	Cause	Remedy
<ul style="list-style-type: none"> • Torque output is extremely low or zero. 	<ul style="list-style-type: none"> • Coil is broken or specified magnetizing current is not running. 	<ul style="list-style-type: none"> • Change product.
<ul style="list-style-type: none"> • Torque generates even when no current is running. • Torque ripple occurs by low torque. 	<ul style="list-style-type: none"> • Residual torque is too large. • Bearing is inferior. 	<ul style="list-style-type: none"> • Do demagnetization with certainty item. (Refer to 4.3) • Change product.
<ul style="list-style-type: none"> • Surface temperature exceeds 80°C (spontaneous cooling) 	<ul style="list-style-type: none"> • Overload. 	<ul style="list-style-type: none"> • Relax the conditions of use.
<ul style="list-style-type: none"> • Rotor does not rotate smoothly. 	<ul style="list-style-type: none"> • Defective bearing. 	<ul style="list-style-type: none"> • Change product.

 CAUTION	Use thermometer when measuring temperature.
	Don't touch directly by hand to avoid burns. Turn off the power source, and make sure the rotating elements are stopped still, and measure with thermometer. Measure promptly.

In the event of a serious trouble, call our agent, service center, or sales office, by specifying the manufacturing serial number together with the type name of the clutch and brake.

For repair or disassembly services, please call our designated service network.

Mitsubishi Electric is not responsible for any damage or trouble caused by repair, disassembly or modification of the product by any third party other than Mitsubishi or specified agent.

8. Specification

(1) ZHA-0.6B ~ 60A hysteresis clutch

Rated voltage : DC24V

Specification	Type	ZHA-0.6B	ZHA-1.2A	ZHA-2.5A	ZHA-5A	ZHA-10A	ZHA-20A	ZHA-40A	ZHA-60A
Torque (N•m)		0.06	0.12	0.25	0.5	1	2	4	6
Rated current (A/75°C)		0.38	0.41	0.52	0.62	1.00	1.21	1.62	2.10
Coil resistance (Ω /75°C)		63.3	57.2	46.2	38.6	24.0	19.8	14.8	11.4
Coil insulation resistance		10 M Ω or more by DC 500 V megger, at ordinary temperature and humidity							
Product mass (kg)		0.46	0.8	1.25	2	3.5	6.5	11	16.5
Bearing		6000 6800 696 625	6001 626	6002 627	6003 628	6005 6004	6007 6005	6009 6007	6010 6010
Allowable continuous heat dissipation (W)		Refer to fig. 6							
Stator(Second rotor above ZHA-10A) tightening bolt strength		Strength division II column 4T or equivalent of JIS B 1051 for mechanical properties of bolts and machine screws.							
Tightening torque (N•m)		2.1~3.5			1.1~1.8		2.1~3.5		3.7~6.2
Allowable rotating speed (r/min)		3600				3000			

(2) ZHY-0.03B ~ 5A hysteresis brake

Rated voltage : DC24V

Specification	Type	ZHY-0.03B	ZHY-0.08B	ZHY-0.3B	ZHY-0.6B	ZHY-1.2A	ZHY-2.5A	ZHY-5A
Torque (N•m)		0.003	0.008	0.03	0.06	0.12	0.25	0.5
Rated current (A/75°C)		0.14	0.14	0.17	0.20	0.28	0.36	0.47
Coil resistance (Ω /75°C)		172.1	172.1	141.0	117.7	87.2	66.7	51.6
Coil insulation resistance		10 M Ω or more by DC 500 V megger, at ordinary temperature and humidity.						
Product mass (kg)		0.13	0.13	0.24	0.32	0.85	1.2	2.0
Bearing		692	692	694	696	626	627	628
Allowable continuous heat dissipation (W)		Refer to fig. 6						
Stator tightening bolt strength		Strength division II column 4T or equivalent of JIS B 1051 for mechanical properties of bolts and machine screws.						
Tightening torque (N•m)		0.49~0.81			1.1~1.8		2.1~3.5	
Allowable rotating speed (r/min)		5000				3600		

(3) ZHY-10A ~ 60A, 100A₂ hysteresis brake

Rated voltage : DC24V

Specification	Type	ZHY-10A	ZHY-20A	ZHY-40A	ZHY-60A	ZHY-100A ₂
Torque (N•m)		1	2	4	6	10
Rated current (A/75°C)		1.00	1.25	1.58	2.20	2.00
Coil resistance (Ω/75°C)		24.3	19.1	15.2	10.8	12.0
Coil insulation resistance	10 MΩ or more by DC 500 V megger, at ordinary temperature and humidity.					
Product mass (kg)		4.0	8.5	10.5	15	19
Bearing		6005	6008	6010	6013	6210
Allowable continuous heat dissipation (W)	Refer to fig. 6					
Stator and rotor tightening bolt strength	Strength division II column 4T or equivalent of JIS B 1051 for mechanical properties of bolts and machine screws.					
Stator tightening torque (N•m)		2.1~3.5	3.7~6.2			17.9~29.8
Rotor Tightening torque (N•m)		2.1~3.5	3.7~6.2			
Allowable rotating speed (r/min)		3000			1800	

9. Others

- (1) In the product having a three-digit figure attached to the model name such as 001 in ZHY-0.03B-001, the mounting dimensions, voltage and other conditions are special, and may differ from the description herein, but the basic operation and handling cautions are common.
- (2) The structural diagrams are representative examples, and may differ depending on the model and options including the specification. Inquire us for details.